

SHAD

MOTOR CASES SOFT BAGS QUAD CASES COMFORT SEATS

SHAD

SHAD

Línea para ESPAÑA

Teléfono: +34 935 795 870

Ligne pour la FRANCE

Téléphone: +34 935 795 868

SHAD

Octave Lecante, 2-6
Pol. Ind. Can Magarola
08100 Mollet del Vallès · Barcelona · Spain
Tel.: +34 935 795 860
Fax: +34 935 796 945

Shad ASIA

Room 11P14,16No.2299 YAN AN Road (West)
Changning District · Shanghai · China
Tel.: +86 21 62365730
Fax: +86 21 62365730

Shad BRASIL

Rua Lagoa Nova, 94 · Jd. Califórnia
CEP 06409-090 · Barueri · SP · Brasil
Tel.: 011 3721 2322
Fax: 011 4199 0356

www.shad.es

info@shad.es

NADSL reserves the right to amend its model's specifications without prior notice.

NADSL se reserva el derecho de modificar las especificaciones de sus modelos sin previo aviso.

NADSL se réserve le droit de modifier ses modèles sans préavis.

NADSL behält sich das Recht vor, die Merkmale seiner Modelle ohne Ankündigung zu ändern.

La NADSL si riserva il diritto di modificare i propri modelli e le loro applicazioni senza preavviso.

NADSL reserva-se o direito de modificar as especificações dos seus modelos sem prévio aviso.

2011-12 COLLECTION

MOTOR CASES · SOFT BAGS · QUAD CASES · COMFORT SEATS

❖ MOTOR CASES

❖ SOFT BAGS

❖ QUAD CASES

❖ COMFORT SEATS



COMPANY PROFILE

SHAD was founded in Barcelona in 1992. It is the first Spanish brand that manufactures and distributes top cases for motorcycles. Over the years, it has become the leading company in its market in several countries. The company now has more than 60 wholesalers in the world.

The brand **SHAD** was created to give a name to the motorcycle accessories that NADSL distributes. NADSL was founded over more than 30 years ago. The main company activity is the manufacture of quality standard seats and top cases for motorcycles. NADSL is the leading European company in manufacturing top cases and seats for the main European manufacturers.

SHAD wurde 1992 als erste spanische Firma für die Herstellung und Vermarktung von Koffern für Motorräder gegründet. Mit den Jahren ist sie zum Marktführer in verschiedenen Ländern geworden und verfügt bereits über mehr als 60 Vertreter weltweit.

SHAD wurde kreiert, um den von NADSL vertriebenen Motorrad-Zubehörteilen einen Namen zu geben. NADSL wurde vor mehr als 30 Jahren gegründet stellt hauptsächlich Sättel und Koffer für die Erstausrüstung von Motorrädern her. Als europäischer Marktführer in der Herstellung von Koffern, stützt NADSL Sitzbänke für die wichtigsten europäischen Hersteller aus.

SHAD nace en Barcelona el año 1992 como la primera marca española dedicada a la fabricación y distribución de maletas para motocicletas. A lo largo de los años se ha convertido en líder de mercado en varios países, hasta conseguir tener más de 60 distribuidores en todo el mundo.

La marca **SHAD** fue creada para dar nombre a los accesorios de motos que distribuye NADSL, empresa fundada hace más de 30 años, cuya actividad principal es la fabricación de sillines y maletas de primera equipación para motocicletas. NADSL, líder europeo en fabricación de maletas, equipa asientos para los principales fabricantes europeos.

SHAD nasce a Barcellona nell'anno 1992 come la prima marca spagnola dedicata alla fabbricazione e distribuzione di bauletteri per motociclette. Durante tutti questi anni si è convertita nel leader del mercato di vari paesi, fino ad ottenere più di 60 distributori in tutto il mondo.

La marca **SHAD** fu creata per dar il nome agli accessori delle moto che distribuisce NAD SL, ditta fondata più di 30 anni fa, che, principalmente fabbrica sellini e bauletteri di prima tenuta per motociclette. NAD SL, leader europeo in fabbricazione di bauletteri per i principali fabbricanti europei.

SHAD, première marque espagnole consacrée à la fabrication et distribution de top cases pour motos, est née en 1992. Elle est devenue au fil des ans leader sur le marché de plusieurs pays, au point de compter actuellement plus de 60 distributeurs à travers le monde.

La marque **SHAD** a été créée pour donner un nom aux accessoires de moto distribués par NADSL, entreprise fondée il y a plus de 30 ans, dont l'activité principale consiste à fabriquer des selles et des top cases de premier équipement pour motos. NADSL, leader européen dans la fabrication de top cases, équipe les selles des principaux fabricants européens.

A marca **SHAD** nasce em Barcelona no ano 1992 como a primeira marca espanhola dedicada à fabricação e distribuição de malas para motociclistas. Ao longo dos anos se converteu em líder de mercado em vários países, alcançando mais de 60 distribuidores no mundo inteiro.

A marca **SHAD** foi criada para dar nome aos acessórios de motos que distribui a empresa NAD.S.L., fundada há mais de 30 anos tendo como atividade principal a fabricação de bancos e malas para motocicletas. NAD.S.L. é líder europeu em fabricação de malas e montagem dos bancos nas motos das principais montadoras européias.



QUALITY

From the start, SHAD's commitment has been to offer a high quality standard product, the result of constant innovation and continuous improvement in the management system. In this sector, the quality standards department holds a key role in controlling and supervising the different production lines.

ISO 9002_ The high technological quality obtained in the development and manufacture of their products has made it possible for NADSL to hold the most prestigious quality standards, amongst such, ISO 9002 is included to the quality standards.

Desde su inicio, el compromiso de SHAD ha sido ofrecer un producto de alta calidad, fruto de la innovación constante y la mejora continua en el sistema de gestión. En este ámbito, el departamento de calidad ostenta un papel clave en el control y supervisión de las diferentes líneas de producción.

ISO 9002_ El alto nivel tecnológico adquirido en el desarrollo y fabricación de sus productos ha hecho posible que NADSL ostente las certificaciones de calidad más prestigiosas, entre las cuales está la ISO 9002 a la garantía de calidad.

Dès ses débuts, SHAD s'est engagée à offrir un produit de haute qualité, issu d'une constante innovation et de l'amélioration continue de son système de gestion. Le département de qualité joue un rôle clé dans ce domaine, grâce au contrôle et à l'encadrement qu'il exerce sur les lignes de production.

ISO 9002_ Forte d'un haut niveau de technologie acquis dans le cadre du développement et de la fabrication de ses produits, NADSL s'est vue décerner les certificats de qualité les plus prestigieux, entre autres le certificat ISO 9002 de garantie de qualité.

Von Anfang an bestand die Verpflichtung von SHAD darin, ein hochwertiges Produkt anzubieten - das Ergebnis konstanter Innovation und ständiger Verbesserung des Managementsystems. In diesem Bereich spielt die Qualitätsabteilung bei der Kontrolle und Überwachung der verschiedenen Produktionslinien eine sehr wichtige Rolle.

ISO 9002_ Dank des hohen technologischen Niveaus, das bei der Entwicklung und Herstellung der Produkte erlangt wurde, hat NADSL die angesehensten Qualitätszertifikate - wie die Qualitätsgarantie ISO 9002 - vorzuweisen.

Fin dall'inizio, l'impegno di SHAD, è stato quello di offrire un prodotto di alta qualità, frutto della continua innovazione ed i continui aggiornamenti nel sistema di gestione. In questo ambito, il reparto di qualità, apporta un lavoro chiave, nel controllo e supervisione delle differenti linee dei prodotti.

ISO 9002_ L'alto livello tecnologico acquisito nello sviluppo e la fabbricazione dei sui prodotti, ha reso possibile il fatto che NAD SL possa ostentare i certificati di qualità più prestigiosi, tra i quali, la ISO 9002 e la garanzia di qualità.

Desde seu inicio, o compromisso da SHAD é oferecer um produto de alta qualidade, fruto da inovação constante e da melhoria continua no sistema de gestão. Neste aspecto, o departamento de qualidade é um ponto essencial para manter o controle e a supervisão das diversas linhas de produção.

ISO 9002_ Com os altos níveis tecnológicos adquiridos no desenvolvimento e fabricação dos seus produtos, a NAD.S.L. possui as certificações de qualidade mais prestigiosas, entre as quais encontra-se a ISO 9002.





AROUND THE WORLD

 SHAD Spain
 SHAD España
 SHAD Espagne
 SHAD Spanien
 SHAD Spagna
 SHAD Espanha

 SHAD USA & North America
 SHAD USA y Norte América
 SHAD États-Unis et Amérique du Nord
 SHAD USA und Nordamerika
 SHAD USA e America del Nord
 SHAD EUA e Norte América

 SHAD France
 SHAD Francia
 SHAD France
 SHAD Frankreich
 SHAD França
 SHAD França

 SHAD South America and Central America
 SHAD Sud América y Centro América
 SHAD Amérique du Sud et Amérique Centrale
 SHAD Mittel-Und Südamerika
 SHAD Sudamerica e Centroamerica
 SHAD América do Sul e Centrala

 SHAD Europe
 SHAD Europa
 SHAD Europe
 SHAD Europa
 SHAD Europa
 SHAD Europa

 SHAD Asia & Australia
 SHAD Asia y Austrália
 SHAD Asie et Australie
 SHAD Asien und Australien
 SHAD Ásia e Austrália
 SHAD Ásia e Austrália



EXPERIENCE

When purchasing any SHAD product, it includes maximum quality, innovative aesthetics and special features. More than 20 years in the sector guarantees great experience in the development of each SHAD product.

SHAD's technical department sees each new product as constant progress and improvement. New technical and aesthetic concepts combined with true knowledge of the market and its needs, allows SHAD to offer a practical and comfortable product.

Adquirir cualquier producto SHAD garantiza la máxima calidad, una estética innovadora y altas prestaciones. Los más de 20 años en el sector, garantiza una gran experiencia en el desarrollo de cada producto SHAD.

El departamento técnico de SHAD afronta cada nuevo proyecto como una evolución y mejora constantes. Nuevos conceptos técnicos y estéticos, combinados con un profundo conocimiento del mercado y de sus necesidades, que permite a SHAD ofrecer un producto práctico y cómodo.

En achetant un produit SHAD, on bénéficie de la plus grande qualité, d'une esthétique innovatrice et de grandes prestations. Riche de ses plus de 20 ans d'activité dans le secteur, SHAD met cette grande expérience au service du développement de chaque produit.

Le département technique de SHAD voit dans chaque projet une occasion d'évoluer et de s'améliorer. C'est sa profonde connaissance du marché et de ses besoins allée à de nouveaux concepts techniques et esthétiques qui permettent à SHAD d'offrir des produits pratiques et confortables.

Der Kauf eines Produktes von SHAD gewährleistet höchste Qualität, eine innovative Ästhetik und starke Leistungen. Mehr als 20 Jahre in der Branche garantieren eine weitreichende Erfahrung bei der Entwicklung eines jeden SHAD-Produktes.

Die technische Abteilung von SHAD sieht jedes neue Projekt als konstante Evolution und Verbesserung. Neue technische und ästhetische Konzepte, angehäuft mit tiefgehenden Marktkenntnissen und seine Bedürfnisse, ermöglichen es SHAD, ein praktisches und bequemes Produkt anzubieten.

Acquistare qualsiasi prodotto SHAD garantisce la massima qualità, un'estetica innovatrice ed alte prestazioni. I più di 20 anni nel settore garantiscono una grande esperienza nello sviluppo di ogni prodotto SHAD.

Il reparto tecnico di SHAD affronta tutti i nuovi progetti come un'evoluzione e miglioramento costante. Nuovi concetti tecnici ed estetici, combinati con un profondo conoscenza del mercato e delle sue necessità, che permettono a SHAD di offrire un prodotto pratico e comodo.

A aquisição de qualquer produto SHAD garante a máxima qualidade, um design inovador e altos rendimentos. Há mais de 20 anos no setor, a SHAD garante grande experiência no desenvolvimento de cada produto.

O departamento técnico da SHAD afronta cada novo projeto como uma evolução e melhoria contínua. Novos conceitos técnicos e estéticos, combinados com um grande conhecimento do mercado e das suas necessidades, permitem a SHAD oferecer um produto pratico e confortável.

SHAD



 Capacity 1 integral helmet
Capacidad 1 casco integral
Capacité 1 casque intégral
Volumen für 1 integralhelm
Capacità 1 casco integrale
Capacidade 1 capacete integral

 Light
Luz
Leux
Feux
Licht
Luce
Luz

 Map holder
Sujeta mapa
Portecarte
Kartenfach
Portacartina
Porta mapa

 Capacity 2 integral helmets
Capacidad 2 cascos integrales
Capacité 2 casques intégral
Volumen für 2 integralhelm
Capacità 2 caschi integral
Capacidade 2 capacetes integrais

 Press lock system

 Thermo Pad
Kit Térmico
Kit Thermique
Kit Térmico
Thermischer Kit
Kit Térmico

 Capacity 1 jet helmet
Capacidad 1 casco jet
Capacité 1 casque jet
Volumen für 1 helm jet
Capacità 1 casco jet
Capacidade 1 capacete jet

 GPS holder
Sujeta GPS
Porte GPS
GPS Ablagemöglichkeit
Porta GPS
Porta GPS

 Rain cover
Bolsa Impermeable
Hausse Imperméable
Regenhaube
Borsa Impermeabile
Bolsa Impermeável

 Capacity 2 helmets: integral and jet
Capacidad 2 cascos: integral y jet
Capacité 2 casques: intégral et jet
Volumen für 2 helme: integralhelm und jet
Capacità 2 caschi: integrale e jet
Capacidade 2 capacetes: integral e jet

 Shoulder Strap
Bandolera
Bandoulière
Tragegurt
Tracolla
Bandoleira

 Water resistant zip
Cremallera Impermeable
Fermeture Imperméable
Wasserdichter Reissverschluss
Chiusura Impermeabile
Zipper Impermeável

 Capacity 2 jet helmets
Capacidad 2 cascos jet
Capacité 2 casques jet
Volumen für 2 helme jet
Capacità 2 caschi jet
Capacidade 2 capacetes jet

 Expandable
Extensible
Extensible
Ausdehnbar
Espandibile
Estensível

 Capacity
Capacidad
Capacité
Volumen
Capacità
Capacidade

 Capacity gloves and integral helmet
Capacidad guantes y casco integral
Capacité gants et 1 casque intégral
Volumen für handschuhe und 1 integralhelm
Capacità guanti ed 1 casco integral
Capacidade luvas e capacete integral

 Magnetic
Magnética
Magnétique
Magnétique
Magnético

 Maximum Load
Carga Máxima
Charge Maximum
Maximale Last
Carica Massima
Carga Máxima

 Capacity gloves and 2 jet helmets
Capacidad guantes y 2 cascos jet
Capacité gants et 2 casques jet
Volumen für handschuhe und 2 helme jet
Capacità guanti e 2 caschi jet
Capacidade luvas e 2 capacetes jet

 Suction Cups
Ventosas
Ventouses
Saugknöpfe
Ventose
Ventosa

 Bielastic Foam

 Protected
Protección
Protégée
Schutz
Protezione
Protecção

 Extra attachment straps
Correas extra de fijación
Sangles de fixation extra
Sicherheitsgurt
Cinghie di attacco extra
Correias de fixação extra

 Waterproof
Impermeable
Imperméable
Wasserdicht
Impermeabile
Impermeável

 Backrest
Respaldo
Dossieret
Rückenpolster
Schienale Encosto

 Convertible in backpack
Transformable en mochila
Transformable en sac à dos
In einen rucksack umwandelbar
Transformabile in zainetto
Transformável en mochila

 Increase of contact surface
Incremento superficie de contacto
Incrément de la surface de contact
Erhöhte Auflagefläche
Aumento de la superficie de contacto
Aumento de la superficie de contato

 SHAD change colour system

 Extra elastic straps
Correas elásticas extra
Extra sangles élastiques
Elastikgurt
Cinghie elastiche extra
Correias elásticas extra

TOP & SIDE CASES

pages 10 to 39

SH50  p. 12/13	SH49  p. 14/15	SH48  p. 16/17	SH46  p. 18/19	SH45 WHITE & RED  p. 20/21	SH43 SIDE CASE WHITE & RED  p. 22/23	SH42 TOP & SIDE CASE  p. 24/25
SH40  p. 26/27	SH40 CARGO  p. 28/29	SH37  p. 30/31	SH33  p. 32/33	SH32 CUSTOM  p. 34/35	SH29  p. 36/37	SH26  p. 38/39

BACK REST

page 42



SISSYBARS & CHROMED RACKS

page 43

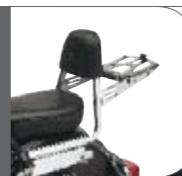

NEW SHAD SPORT RACK

page 44



ATTACHMENT SUPPORTS

page 45



FITTING KITS

pages 46 to 47

SHAD STYLE COMFORT SEATS

pages 48 to 53

YAMAHA X-MAX  p. 49	YAMAHA T-MAX  p. 50	YAMAHA FAZER FZ6  p. 50	YAMAHA FAZER FZ8  p. 51	YAMAHA XJ6  p. 51
KAWASAKI Z750/1000  p. 52	KAWASAKI ER6  p. 52	SUZUKI GLADIUS  p. 53	PIAGGIO MP3  p. 53	

SOFT BAGS

pages 54 to 65

SB70 REAR BAG  p. 56	SB60 SADDLE BAG  p. 57	SB50 SADDLE BAG  p. 56	SB90 BACKPACK  p. 58	SB80 BACKPACK  p. 58	SB30 TANK BAG  p. 59	SB25 TANK BAG  p. 59
SB22 TANK BAG  p. 60	SB20 TANK BAG  p. 60	SB15 GPS TANK BAG  p. 61	SB10 GPS TANK BAG  p. 61	SB12 TANK POUCH  p. 62	SB11 TANK POUCH  p. 62	SC30 SCOOTER BAG  p. 63
SC20 SCOOTER BAG  p. 63	SB45 HOLSTER BAG  p. 64	SB40 HOLSTER BAG  p. 64	SBT2 TOOL BAG  p. 65	SBT1 TOOL BAG  p. 65		

ATV CASES

pages 66 to 75

SHATV110  p. 68/69	SHATV80  p. 70/71	SHATV40  p. 72/73	ATVBAG50  p. 74	ATVBAG100  p. 75
--	---	---	---	--

SPARE PARTS

pages 76 TO 83

STANDS

page 85

SHAD
TOP CASES ❖



Ref.: D1B48PA

- Standard bottom # Included
- Pletina standard # Incluída
- Pletine standard # Includere
- Standard-Adapterplatte # Inbegriffen
- Piastra standard # Inclusa
- Platina standard # Incluída



CHARACTERISTICS

Page 8



ACCESSORY
DOB50KL

Hermetic sealing system

Sistema de cierre hermético

Système de fermeture hermétique

Hermetisches verschlussssystem

Sistema chiusura ermetica

Sistema de fechamento hermético



Ref.: D0R170

Backrest # Included

Respaldo # Incluído

Dosseret # Includere

Rückenpolster # Inbegriffen

Schienale # Inclusa

Encosto # Incluído



ACCESSORY

Ref.: DOB50KL

Light · Luz · Feux · Licht
Luce · Luz



CHANGE COLOUR SYSTEM

Motorcycle Specific Colours



Black / Negro / Noir / Schwarz
Nero / Preto

Ref.: DOB5000



Blue / Azul / Bleu / Blau
Blu / Azul

Ref.: DOB5000 + D1B50E01



Silver / Plata / Argent / Silber
Argento / Prateado

Ref.: DOB5000 + D1B50E05



Titanium / Titano / Titane / Titan
Titânio / Titânio

Ref.: DOB5000 + D1B50E07



White / Blanco / Blanc / Weiß
Bianco / Branco

Ref.: DOB5000 + D1B50E08



Red / Rojo / Rouge / Rot
Rosso / Vermelho

Ref.: DOB5000 + D1B50E09



Black metal / Negro metal / Noir métal Schwarz
metallic / Nero metallo / Preto metalizado

Ref.: DOB5000 + D1B50E21



TOP CASES

Ref.: D1B48PA

- Standard bottom # Included
- Pletina standard # Incluida
- Pletine standard # Includuse
- Standard-Adapterplatte # Inbegriffen
- Piastra standard # Inclusa
- Platina standard # Incluida



CHARACTERISTICS

Page 8



ACCESSORY
DOR160

ACCESSORY
DOB50KL

Hermetic sealing system

- Sistema de cierre hermético
- Système de fermeture hermétique
- Hermetisches verschlussssystem
- Sistema chiusura ermetica
- Sistema de fechamento hermético



ACCESSORY

Ref.: DOR160

- Backrest
- Respaldo
- Dosseret
- Rückenpolster
- Schienale
- Encosto



ACCESSORY

Ref.: DOB50KL

- Light
- Luz
- Feux
- Licht
- Luce
- Luz



SH49

Ref.: DOB4900



Ref.: D1B48PA

- Standard bottom # Included
- Pletina standard # Incluida
- Pletine standard # Includere
- Standard-Adapterplatte # Inbegriffen
- Piastra standard # Inclusa
- Platina standard # Incluída



CHARACTERISTICS

Page 8



ACCESSORY
DOR14800

ACCESSORY
DOB50KL

Hermetic sealing system

- Sistema de cierre hermético
- Système de fermeture hermétique
- Hermetisches verschlusssystem
- Sistema chiusura ermetica
- Sistema de fechamento hermético



CHANGE COLOUR SYSTEM

Motorcycle Specific Colours



ACCESSORY

Ref.: DOR14800

- Backrest · Respaldo
- Dosseret · Rückenpolster
- Schienale · Encosto



ACCESSORY

Ref.: DOB50KL

- Light · Luz · Feux · Licht
- Luce · Luz



Dark grey / Gris oscuro / Gris foncé
Dunkelgrau / Grigio scuro / Cinza escuro
Ref.: DOB48100 NO COVER



New Titanium / New Titano / New Titane
New Titan / New Titano / New Titânio
Ref.: DOB48200 NO COVER



Dark grey / Gris oscuro / Gris foncé
Dunkelgrau / Grigio scuro / Cinza escuro
Ref.: DOB48100 + D1B48E17



New Titanium / New Titano / New Titane
New Titan / New Titano / New Titânio
Ref.: DOB48200 + D1B48E15



Dark Grey-Carbon / Gris Oscuro-Carbono
Gris Foncé-Carbono / Dunkel Grau-Carbono
Grigio Scuro-Carbonio / Cinza Escuro-Carbono
Ref.: DOB48100 + D1B48E06



New titanium-Carbon / New Titano-Carbono
New Titane-Carbono / New Titan-Carbono
New Titânio-Carbonio / New Titânio-Carbono
Ref.: DOB48200 + D1B48E06

White / Blanco / Blanc / Weiß
Bianco / Branco
Ref.: DOB48100+D1B48E08
Ref.: DOB48200+D1B48E08

Black metal / Negro metal / Noir métal
Schwarz metallic / Nero metallo / Preto metalizado
Ref.: DOB48100+D1B48E21
Ref.: DOB48200+D1B48E21



New Titanium

Dark Grey

TOP CASES

Ref.: D1B40PA

- Standard bottom # Included
- Pletina standard # Incluída
- Pletine standard # Includere
- Standard-Adapterplatte # Inbegriffen
- Piastra standard # Inclusa
- Platina standard # Incluída



CHARACTERISTICS

Page 8



ACCESSORY
D0R150

ACCESSORY
D0B40KL

CHANGE COLOUR SYSTEM

Motorcycle Specific Colours



ACCESSORY

Ref.: D0R150

- Backrest
- Respaldo
- Dosseret
- Rückenpolster
- Schienale
- Encosto



ACCESSORY

Ref.: D0B40KL

- Light
- Luz
- Feux
- Licht
- Luce
- Luz



Black / Negro / Noir / Schwarz
Nero / Preto
Ref.: D0B46100



31 cm.
58 cm. 42 cm.



Blue / Azul / Bleu / Blau
Blu / Azul
Ref.: D0B46100 + D1B46E01



Silver / Plata / Argent / Silber
Argento / Prateado
Ref.: D0B46100 + D1B46E05



Titanium / Titano / Titane / Titan
Titano / Titânio
Ref.: D0B46100 + D1B46E07



White / Blanco / Blanc / Weiß
Bianco / Branco
Ref.: D0B46100 + D1B46E08



Red / Rojo / Rouge / Rot
Rosso / Vermelho
Ref.: D0B46100 + D1B46E09



Black metal / Negro metal / Noir métal Schwarz
metallic / Nero metallo / Preto metalizado
Ref.: D0B46100 + D1B46E21



SH45

RED



CHARACTERISTICS

Page 8



ACCESSORY
D0R160

ACCESSORY
D0B40KL



Black / Negro / Noir / Schwarz
Nero / Preto

Ref.: D0B4500



Blue / Azul / Bleu / Blau
Blu / Azul

Ref.: D0B4500 + D1B45E01



Silver / Plata / Argent / Silber
Argento / Prateado

Ref.: D0B4500 + D1B45E05



Titanium / Titanio / Titane / Titan
Titano / Titânio

Ref.: D0B4500 + D1B45E07



White / Blanco / Blanc / Weiß
Bianco / Branco

Ref.: D0B4500 + D1B45E08



Red / Rojo / Rouge / Rot
Rosso / Vermelho

Ref.: D0B4500 + D1B45E09



Black metal / Negro metal / Noir métal Schwarz
metallic / Nero metallo / Preto metalizado

Ref.: D0B4500 + D1B45E21

SH45

WHITE



Black / Negro / Noir / Schwarz
Nero / Preto

Ref.: D0B45100



Blue / Azul / Bleu / Blau
Blu / Azul

Ref.: D0B45100 + D1B45E01



Silver / Plata / Argent / Silber
Argento / Prateado

Ref.: D0B45100 + D1B45E05



Titanium / Titanio / Titane / Titan
Titano / Titânio

Ref.: D0B45100 + D1B45E07



White / Blanco / Blanc / Weiß
Bianco / Branco

Ref.: D0B45100 + D1B45E08



Red / Rojo / Rouge / Rot
Rosso / Vermelho

Ref.: D0B45100 + D1B45E09



Black metal / Negro metal / Noir métal Schwarz
metallic / Nero metallo / Preto metalizado

Ref.: D0B45100 + D1B45E21

Ref.: D1B40PA

Standard bottom # Included
Pletina standard # Incluída
Pletine standard # Includere
Standard-Adapterplatte # Inbegriffen
Piastra standard # Inclusa
Platina standard # Incluída



JUST STANDARD
COLOURS AVAILABLE



ACCESSORY
Ref.: D0R160

Backrest · Respaldo · Dossieret
Rückenpolster Schienale
Encosto



ACCESSORY
Ref.: D0B40KL

Light · Luz · Feux · Licht
Luce · Luz



LED Technology



TOP CASES

2 SIDE CASES



1 TOP CASE +
2 SIDE CASES

FULL EQUIPMENT

- Greatest capacity
- Máxima capacidad
- La plus grande capacité
- Maximale Kapazität
- Massima capacità
- Máxima capacidade



CHARACTERISTICS

Page 8



SH43

SIDE CASE WHITE

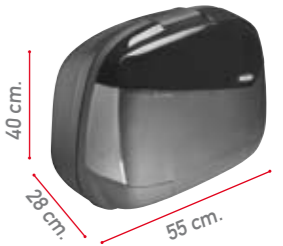

SH43

SIDE CASE RED



Black / Negro / Noir / Schwarz
Nero / Preto

Ref. Red: DOB4310 + D1B43E00
Ref. White: DOB43100 + D1B43E00



Blue / Azul / Bleu / Blau
Blu / Azul

Ref. Red: DOB4310 + D1B43E01
Ref. White: DOB43100 + D1B43E01



Silver / Plata / Argent / Silber
Argento / Prateado

Ref. Red: DOB4310 + D1B43E05
Ref. White: DOB43100 + D1B43E05



Titanium / Titánio / Titane / Titan
Titano / Titânio

Ref. Red: DOB4310 + D1B43E07
Ref. White: DOB43100 + D1B43E07



White / Blanco / Blanc / Weiß
Bianco / Branco

Ref. Red: DOB4310 + D1B43E08
Ref. White: DOB43100 + D1B43E08



Red / Rojo / Rouge / Rot
Rosso / Vermelho

Ref. Red: DOB4310 + D1B43E09
Ref. White: DOB43100 + D1B43E09



New Titanium / New Titánio / New Titane
New Titan / New Titano / New Titânio

Ref. Red: DOB4310 + D1B43E15
Ref. White: DOB43100 + D1B43E15



Dark grey / Gris oscuro / Gris foncé
Dunkelgrau / Grigio scuro / Cinza escuro

Ref. Red: DOB4310 + D1B43E17
Ref. White: DOB43100 + D1B43E17



Black metal / Negro metal / Noir métal
Schwarz metallic / Nero metallo / Preto metalizado

Ref. Red: DOB4310 + D1B43E21
Ref. White: DOB43100 + D1B43E21



Ref.: D1B40PA

Standard bottom # Included
 Pletina standard # Incluida
 Pletine standard # Includere
 Standard-Adapterplatte # Inbegriffen
 Piastra standard # Inclusa
 Platina standard # Includida

ACCESSORY

Ref.: D1RIES

Backrest · Respaldo
 Dossieret · Rückenpolster
 Schienale · Encosto

ACCESSORY

Ref.: DOB40KL

Light · Luz · Feux · Licht
 Luce · Luz

LED Technology

CHARACTERISTICS

Page 8



ACCESSORY
D1RIES

ACCESSORY
DOB40KL

CHARACTERISTICS

Page 8



- SHAD side-mounted case. Supplied in sets of two. Has an inside tray.
- Maleta de SHAD para ser montada especialmente como lateral suministrada en conjuntos de dos unidades. Equipa una bandeja interior.
- Coffre SHAD latéral se présentant sous la forme d'un ensemble de deux unités. Doté d'un plateau intérieur.

- SHAD-Koffer speziell für die Seitenmontage. Als Seitenkofferset ausgestattet mit einem inneren Einlegefach.
- Valigia della SHAD da montare specialmente come borsa laterale. È fornita in gruppi di due unità. È munita di un portaoggetti interno.

- Mala SHAD para ser montada especialmente como lateral. É fornecida em conjuntos de duas unidades. Possui uma bandeja interna.



TOP CASES

Ref.: D1B40PA

- Standard bottom # Included
- Pletina standard # Incluída
- Pletine standard # Includere
- Standard-Adapterplatte # Inbegriffen
- Piastra standard # Inclusa
- Platina standard # Incluída



CHARACTERISTICS

Page 8



ACCESSORY
DOR160

ACCESSORY
DOB40KL

JUST STANDARD COLOURS AVAILABLE



ACCESSORY

Ref.: DOR160

- Backrest
- Respaldo
- Dosseret
- Rückenpolster
- Schienale
- Encosto



ACCESSORY

Ref.: DOB40KL

- Light
- Luz
- Feux
- Licht
- Luce
- Luz



SH40



Black / Negro / Noir / Schwarz
Nero / Preto
Ref.: DOB40100



Blue / Azul / Bleu / Blau
Blu / Azul
Ref.: DOB40100 + D1B40E01



Silver / Plata / Argent / Silber
Argento / Prateado
Ref.: DOB40100 + D1B40E05



Titanium / Titano / Titane / Titan
Titano / Titânio
Ref.: DOB40100 + D1B40E07



White / Blanco / Blanc / Weiß
Bianco / Branco
Ref.: DOB40100 + D1B40E08



Red / Rojo / Rouge / Rot
Rosso / Vermelho
Ref.: DOB40100 + D1B40E09



Black metal / Negro metal / Noir métal Schwarz
metallic / Nero metallo / Preto metalizado
Ref.: DOB40100 + D1B40E21



TOP CASES

Ref.: D1B40PA

- Standard bottom # Included
- Pletina standard # Incluida
- Pletine standard # Includere
- Standard-Adapterplatte # Inbegriffen
- Piastra standard # Inclusa
- Platina standard # Incluida



CHARACTERISTICS

Page 8



ACCESSORY
DOR160

ACCESSORY
DOB40KL

- Elastic Cord # Included
- Pulpo Elástico # Incluido
- Sandow # Includere
- Gummiband # Inbegriffen
- Elastico # Inclusa
- Elástico # Incluida



ACCESSORY

Ref.: DOR160

- Backrest
- Respaldo
- Dosseret
- Rückenpolster
- Schienale
- Encosto



ACCESSORY

Ref.: DOB40KL

- Light
- Luz
- Feux
- Licht
- Luce
- Luz



SH40

CARGO

Ref.: DOB40199



Ref.: D1B37PA

- Standard bottom # Included
- Pletina standard # Incluída
- Pletine standard # Includere
- Standard-Adapterplatte # Inbegriffen
- Piastra standard # Inclusa
- Platina standard # Incluída



CHARACTERISTICS

Page 8



ACCESSORY
DOR160

ACCESSORY
DOB29KL

CHANGE COLOUR SYSTEM

Motorcycle Specific
Colours



ACCESSORY

Ref.: DOR160

- Backrest
- Respaldo
- Dosseret
- Rückenpolster
- Schienale
- Encosto



ACCESSORY

Ref.: DOB29KL

- Light
- Luz
- Feux
- Licht
- Luce
- Luz



Black / Negro / Noir / Schwarz
Nero / Preto
Ref.: DOB37100



31 cm.

49 cm. 40 cm.



Blue / Azul / Bleu / Blau
Blu / Azul
Ref.: DOB37100 + D1B37E01



Silver / Plata / Argent / Silber
Argento / Prateado
Ref.: DOB37100 + D1B37E05



Titanium / Titano / Titane / Titan
Titano / Titânio
Ref.: DOB37100 + D1B37E07



White / Blanco / Blanc / Weiß
Bianco / Branco
Ref.: DOB37100 + D1B37E08



Red / Rojo / Rouge / Rot
Rosso / Vermelho
Ref.: DOB37100 + D1B37E09



Black metal / Negro metal / Noir métal Schwarz
metallic / Nero metallo / Preto metalizado
Ref.: DOB37100 + D1B37E21



SH33

RED



Black / Negro / Noir / Schwarz
Nero / Preto

Ref.: D0B3300



31 cm.

43 cm.

42 cm.



Blue / Azul / Bleu / Blau
Blu / Azul

Ref.: D0B3300 + D1B33E01



Silver / Plata / Argent / Silber
Argento / Prateado

Ref.: D0B3300 + D1B33E05



Titanium / Titanio / Titane / Titan
Titânio / Titânio

Ref.: D0B3300 + D1B33E07



White / Blanco / Blanc / Weiß
Bianco / Branco

Ref.: D0B3300 + D1B33E08



Red / Rojo / Rouge / Rot
Rosso / Vermelho

Ref.: D0B3300 + D1B33E09



Black metal / Negro metal / Noir métal Schwarz
metallic / Nero metallo / Preto metalizado

Ref.: D0B3300 + D1B33E21

CHARACTERISTICS

Page 8



3



ACCESSORY
D0R140



ACCESSORY
D0B29KL



SH33



Black / Negro / Noir / Schwarz
Nero / Preto

Ref.: D0B33100



31 cm.

43 cm.

42 cm.



Blue / Azul / Bleu / Blau
Blu / Azul

Ref.: D0B33100 + D1B33E01



Silver / Plata / Argent / Silber
Argento / Prateado

Ref.: D0B33100 + D1B33E05



Titanium / Titanio / Titane / Titan
Titânio / Titânio

Ref.: D0B33100 + D1B33E07



White / Blanco / Blanc / Weiß
Bianco / Branco

Ref.: D0B33100 + D1B33E08



Red / Rojo / Rouge / Rot
Rosso / Vermelho

Ref.: D0B33100 + D1B33E09



Black metal / Negro metal / Noir métal Schwarz
metallic / Nero metallo / Preto metalizado

Ref.: D0B33100 + D1B33E21

Ref.: D1B29PA

Standard bottom # Included
Pletina standard # Incluída
Pletine standard # Includere
Standard-Adapterplatte # Inbegriffen
Piastra standard # Inclusa
Platina standard # Incluída



JUST STANDARD
COLOURS AVAILABLE



ACCESSORY

Ref.: D0R140

Backrest · Respaldo · Dossieret
Rückenpolster Schienale
Encosto



ACCESSORY

Ref.: D0B29KL

Light · Luz · Feux · Licht
Luce · Luz



LED Technology



TOP CASES

Ref.: D1B29PA

- Standard bottom # Included
- Pletina standard # Incluida
- Pletine standard # Includere
- Standard-Adapterplatte # Inbegriffen
- Piastra standard # Inclusa
- Platina standard # Includida



CHARACTERISTICS

Page 8



ACCESSORY
DOR140



ACCESSORY
DOB29KL

ACCESSORY

Ref.: DOR100

- Backrest
- Respaldo
- Dosseret
- Rückenpolster
- Schienale
- Encosto



ACCESSORY

Ref.: DOB29KL

- Light
- Luz
- Feux
- Licht
- Luce
- Luz



SH32

CUSTOM

Ref.: DOB3211



TOP CASES

Ref.: D1B29PA

- Standard bottom # Included
- Pletina standard # Incluída
- Pletine standard # Includere
- Standard-Adapterplatte # Inbegriffen
- Piastra standard # Inclusa
- Platina standard # Incluída



CHARACTERISTICS

Page 8



ACCESSORY
DOR140

ACCESSORY
DOB29KL

JUST STANDARD COLOURS AVAILABLE



ACCESSORY

Ref.: DOR140

- Backrest
- Respaldo
- Dosseret
- Rückenpolster
- Schienale
- Encosto



ACCESSORY

Ref.: DOB29KL

- Light
- Luz
- Feux
- Licht
- Luce
- Luz



Black / Negro / Noir / Schwarz
Nero / Preto
Ref.: DOB29100



Blue / Azul / Bleu / Blau
Blu / Azul
Ref.: DOB29100 + D1B29E01



Silver / Plata / Argent / Silber
Argento / Prateado
Ref.: DOB29100 + D1B29E05



Titanium / Titanio / Titane / Titan
Titânio / Titânio
Ref.: DOB29100 + D1B29E07



White / Blanco / Blanc / Weiß
Bianco / Branco
Ref.: DOB29100 + D1B29E08



Red / Rojo / Rouge / Rot
Rosso / Vermelho
Ref.: DOB29100 + D1B29E09



Black metal / Negro metal / Noir métal / Schwarz metallic
Nero metallo / Preto metalizado
Ref.: DOB29100 + D1B29E21



TOP CASES

Ref.: D1B29PA

- Standard bottom # Included
- Pletina standard # Incluida
- Pletine standard # Includuse
- Standard-Adapterplatte # Inbegriffen
- Piastra standard # Inclusa
- Platina standard # Incluida



CHARACTERISTICS

Page 8



ACCESSORY
DOB29KL

ACCESSORY

Ref.: DOB29KL

- Light
- Luz
- Feux
- Licht
- Luce
- Luz



LED Technology

SH26

Ref.: DOB26100



SHAD

FITTING KITS & BACKREST ❖



MODEL	BACKREST REF.
HONDA	
SH 125 · SH150 · PASION (05 - 08)	H0SSH15RN
FORESIGHT-PANTHEON 125/150 (98 - 02)	H0F28R
FORZA 250 (05 - 08)	H0FR26RN
FORZA 250 (09 - 11)	H0FR29RN
KYMCO	
XCITING 250/500 (05 - 11) · 500R (10-11)	K0XC55RN
SUPERDINK 125 (09) · DOWNTOWN 125/300 (09-10)	K0SP19RN
PEUGEOT	
ELYSEO 50/100 (98 - 02)	P0E58R
ELYSTAR 50/125/150 (02 - 11)	P0E58R
ELYSEO 125/150 (98 - 04)	P0E58R
PIAGGIO	
FLY 50/125/150 (05 - 10)	V0FL15RN
X8 125/250/500 · XEVO 125/250 (04 - 08) Edición "Abatible"	V0X815RN
X9 125/180/250/500 (00 - 09)	V0X20R
BEVERLY CRUISER 500 (07 - 11)	V0BV57RN
X7 125 (08 - 11)	V0X718RN
X7 125/250/300 EVO (10 - 11)	V0XV30RN
BEVERLY TOURER 125/250/400 (08 - 11)	V0TR18RN
BEVERLY 125ie · 300 ie TOURER (2011)	V0TR18RN
SUZUKI	
BURGMAN 125/150 (02 - 06)	S0BR12RN/S0BR12R
BURGMAN UH 125/200 (07 - 11)	S0BR17RN
BURGMAN 400 X Type S (05 - 06)	S0BR45RN
BURGMAN 400 K7 (2006)	S0BR46RN
BURGMAN 400 (07 - 09)	S0BR46RN
BURGMAN 400 Z (2007)	S0BR46RN
BURGMAN 400 ABS (10 - 11)	S0BR46RN
YAMAHA	
NEO'S 50/100 (97 - 07)	Y0N10RN
MAJESTY 125 (98 - 00)	Y0M18R
MAJESTY 125/150/180 (01 - 09)	Y0M11R
MAJESTY 250 (00 - 09)	Y0M20R
X-MAX 125/250 (05 - 09)	Y0XM25RN
X-MAX 125/250 (10 - 11)	Y0XM20RN
MAYESTY 400 (04 - 06)	Y0MJ44RN
MAJESTY YP400 (10 - 11)	Y0MJ44RN
XP500 T-MAX (01 - 07)	Y0T51RN
T-MAX (08 - 11)	Y0TM58RN
GILERA	
NEXUS 250/500 (06 - 11)	G0NX58RN
NEXUS 125 (06 - 11)	G0NX18RN
GP 800 (08 - 11)	G0GP88RN
TGB	
X-MOTION 125 (09 - 11)	T0XM19RN
APRILIA	
SCARABEO 125/250 (08 - 10)	A0SC18RN
SCARABEO 125ie/250ie (10 - 11)	A0SC18RN



· Upholstery finishing. It can be adapted to the main scooter models on the market.

· Acabados en tapicería. Adaptable a los principales modelos de scooter del mercado.

· Dossierets. Finition en tissu. Adaptable sur les principaux modèles de scooters du marché.



· Rückenpolster. Pasend für die wichtigsten auf dem Markt erhältlichen Scootermodelle.

· Schienali. Finiture in tappezzeria. Adattabile ai principali modelli di scooter del mercato.

· Encostos. Acabamentos estofados. Adaptável aos principais modelos de scooter do mercado.



MODEL	SISSYBARS REF.	1 TOP CASE <small>Chromed Rack Ref.</small>
DAELIM		
DAYSTAR 125 (00 - 11)	D0D10SN	NADTN + D0D10SN
HONDA		
HONDA REBEL 125/250 (96 - 11)	H0R16SN	NADTN + H0R16SN
SHADOW 125 (99 - 11)	H0S19SN	NADTN + H0S19SN
SHADOW 600 (95 - 04)	H0S65SN	NADTN + H0S65SN
KAWASAKI		
VN 900 (07 - 11)	K0VL97SN	NADTN + K0VL97SN
SUZUKI		
INTRUDER 125/250 (99 - 09)	S0I19SN	NADTN + S0I19SN
INTRUDER 125 (2011)	MOUNTED ON THE ORIGINAL SISSYBAR	
MARAUDER 125/250 (98 - 11)	S0M18SN	NADTN + S0M18SN
MARAUDER 800 (97 - 04)	S0M87SN	NADTN + S0M87SN
YAMAHA		
XV 125/250 (94 - 11)	Y0V25SN	NADTN + Y0V25SN
DRAGSTAR CLASSIC 125/250 (99 - 09)	Y0D19SN	NADTN + Y0D19SN
XV535 VIRAGO (95 - 04)	Y0V55SN	NADTN + Y0V55SN
DRAGSTAR CLASSIC 650 (99-03)	Y0D69SN	NADTN + Y0D69SN
HYOSUNG		
AQUILA 125/GV 250 (06 - 11)	H0QL17SN	NADTN + OQL175SN

SISSYBARS



BACKREST



CHROMED RACKS

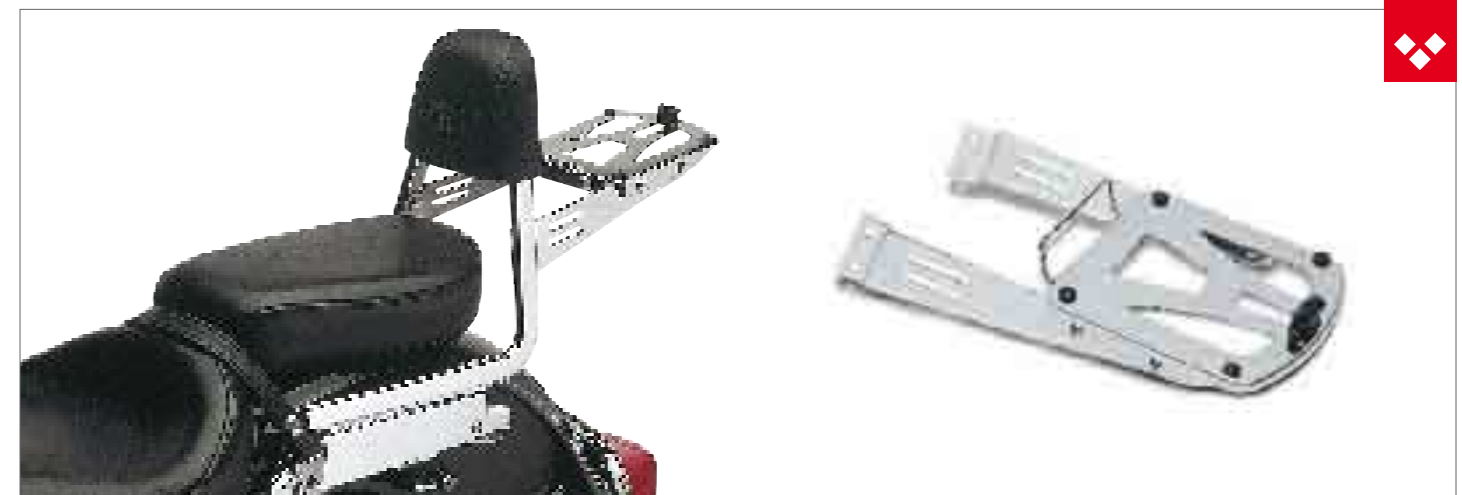

Portapaquetes · Porte-paquets · Adapte platte · Portapacchi · Porta-volumes



AVAILABLE FOR

HONDA CB1000R (2011)	H0CB11CL
KAWASAKI Z750 (07 - 11)	K0Z778CL
KAWASAKI Z1000 (07 - 09)	K0Z778CL
SUZUKI GSR750 (2011)	S0GS71CL
YAMAHA FAZER FZ8 (10 - 11)	Y0FZ80CL



SPORT RACK DETAILS



SHAD has developed the new Top Master and Side Master, a new tubular attachment system that is strong, convenient and safe. This system allows you to fit a topcase on its own using the Top Master, just the sidecases using the Side Master, or the full set. These attachments have been specifically designed for each motorcycle model, taking into account its particular characteristics. The result is a product that is compact, easy to mount and dismount and boasts an extremely strong epoxy finish. Indicators can be included if required.

SHAD ha desarrollado los nuevos Top Master y Side Master, un nuevo sistema de fijación tubular fuerte, cómodo y seguro. Es un sistema que permite montar solamente un topcase mediante el Top Master, sólo las maletas laterales con el Side Master, o bien el conjunto completo. Se trata de fijaciones diseñadas específicamente para cada modelo de motocicleta teniendo en cuenta sus características. El resultado es un producto de montaje y desmontaje fáciles, compacto y con acabado epoxy de gran resistencia. Los intermitentes van incluidos en el conjunto si se requiere.

SHAD a développé les nouveaux Top Master et Side Master, un nouveau système de fixation tubulaire résistant, commode et sûr. Il s'agit d'un système permettant de monter uniquement un topcase au moyen du Top Master, uniquement les valises latérales avec le Side Master, ou l'ensemble complet. Il s'agit de fixations conçues spécifiquement pour chaque modèle de moto en considérant ses caractéristiques. Le résultat obtenu est un produit facile à monter et à démonter, compact et avec une finition époxy de grande résistance. Les clignotants sont compris dans l'ensemble dans le cas où c'est nécessaire.

SHAD hat die neuen Top Master und Side Master entwickelt, neue Trägersysteme in stabiler Rohr, komfortabel und sicher. Damit ist es möglich, entweder nur ein Topcase mit dem Top Master, nur die Seitenkoffer mit dem Side Master oder das gesamte Set zu montieren. Es handelt sich um Trägersysteme, die für jedes Motorradmodell unter Berücksichtigung der jeweiligen technischen Eigenschaften speziell entworfen wurden. Als Resultat wurde ein kompaktes Produkt erzielt, das leicht an- und abmontiert werden kann und mit einer hochresistenten Epoxybeschichtung versehen ist. Die Blinker sind bei Bedarf im Set inbegriffen.

SHAD ha sviluppato i nuovi Top Master e Side Master, nuovi sistemi di fissaggi tubolari solidi, comodi e sicuri. E' un sistema che permette di montare un singolo topcase mediante il Top Master, le singole borse laterali con il Side Master, oppure l'intero gruppo. Si tratta di fissaggi particolarmente disegnati per ogni modello di motocicletta, tenendo conto delle caratteristiche specifiche. Il risultato è un prodotto dal facile montaggio e smontaggio, compatto e con finitura epossica altamente resistente. Le frecce sono inserite nella confezione, quando necessarie.

SHAD desenvolveu os novos Top Master e Side Master, um novo sistema de fixação tubular forte, cómodo e seguro. É um sistema que permite montar apenas uma topcase mediante o Top Master-, apenas as malas laterais -com o Side Master- ou o conjunto completo. São fixações concebidas especificamente para cada modelo de motocicleta, de acordo com as suas características particulares. O resultado é um produto de montagem e desmontagem fáceis, compacto e com acabamento epoxy muito resistente. Os pisca-piscas são incluídos no conjunto quando é necessário.

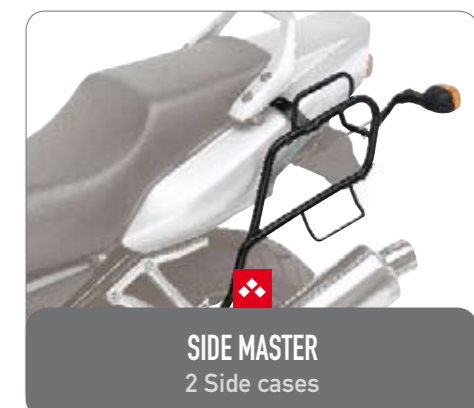

TOP MASTER SPECIFICATIONS

Top Case attachment kit with 3-degree-interval adjustable support. Robust and easy to fit. Epoxy paint finish. To fit a Top Case on your bike, you will need a bottom rack Ref.D1B40PA which is automatically supplied with some of the SHAD Top Cases.

Conjunto de fijación para montaje de un Top Case con soporte regulable a intervalos de 3 grados. Rigidez y facilidad de montaje. Acabados en pintura epoxy. Para el montaje del Top Case en la motocicleta es necesario añadir a este kit la pletina Ref.D1B40PA, ya incluida en algunos de los Top Case SHAD.

Ensemble de fixation pour le montage d'un Top Case, avec support réglable par intervalles de 3 degrés. Rigidité et facilité de montage. Finition en peinture époxy. Pour monter le Top Case sur la motocyclette, il faut ajouter à ce kit la platine Réf. D1B40PA, déjà comprise sur certains modèles de Top Case SHAD.

Befestigungskit für die Montage eines Top Case, mit dreistufig regulierbarem Halter. Einfache und solide Montage. Epoxyausführung. Für die Montage des Top Case auf das Motorrad ist die Platte Ref. D1B40PA erforderlich, die in einigen SHAD-Top Cases bereits enthalten ist.

Supporto di fissaggio per il montaggio dei Top Case, regolabile a scatti di tre gradi, rigido e facile da montare, verniciatura epoxy. Con questo kit per il montaggio del Top Case è necessario utilizzare la piastra Rif.D1B40PA, già compresa in alcuni dei Top Case SHAD.

Conjunto de fixação para montagem de uma Top Case com suporte regulável a intervalos de 3 graus. Rigidez e facilidade de montagem. Acabamentos de tinta epoxy. Para a montagem da Top Case na motocicleta é preciso acrescentar a este kit a platina Ref.D1B40PA, já incluída em algumas das Top Cases SHAD.

SHAD *style*

NEW RANGE SHAD STYLE COMFORT SEATS

When style becomes COMFORT

- ✓ MORE ERGONOMY: 15-20% increase of surface contact.
- ✓ MORE DURABILITY: Top-quality materials.
- ✓ BETTER PERFORMANCE: Bielastic Foam Technology.
- ✓ BETTER SERVICE: 100% new and complete seat.

Coming SOON

HONDA

- CBF 600 (09 - 11)
- CBF 1000 (09 - 11)
- CBR 600 F (2011)
- HORNET 600 (2011)

SUZUKI

- BANDIT 650 (09 - 11)
- GSR750 (2011)

More seats at www.shad.es

YAMAHA X-MAX



YAMAHA X-MAX 125/250 (10 - 11)
MBK SKYCRUISER 125 (10 - 11)

CHARACTERISTICS



See on page num. 8

AVAILABLE COLOURS



Ref.: SHY0X2000

Ref.: SHY0X2010

Ref.: SHY0X2006



Ref.: SHY0X2006

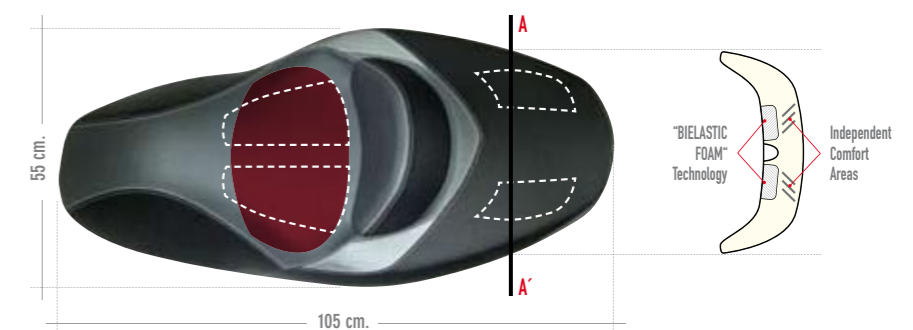

--- Bielastic Foam Technology ■ Contact Surface

YAMAHA T-MAX



Ref.: SHYOT5000

T-MAX 500 (08 - 11)

CHARACTERISTICS



See on page num. 8

AVAILABLE COLOURS



Ref.: SHYOT5000 Ref.: SHYOT5010 Ref.: SHYOT5006

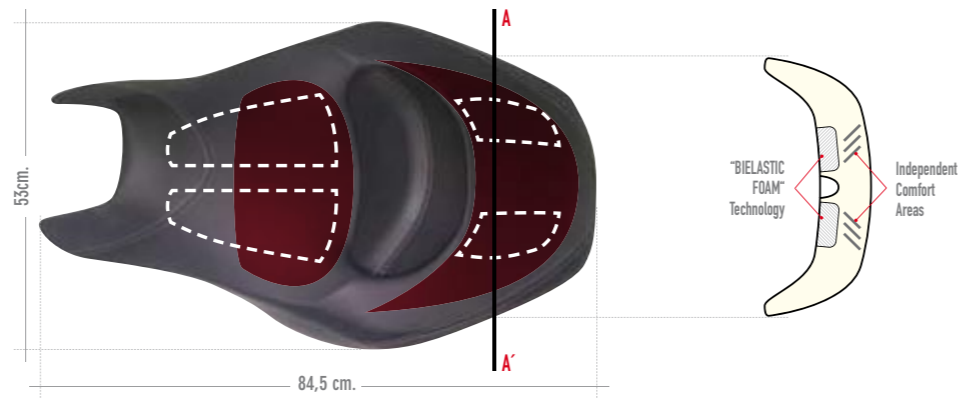

--- Bielastic Foam Technology ■ Contact Surface

YAMAHA FAZER FZ8



Ref.: SHYOF810C

FAZER FZ8 (10 - 11)

CHARACTERISTICS



See on page num. 8

AVAILABLE COLOURS



Ref.: SHYOF810C Ref.: SHYOF811C Ref.: SHYOF812C

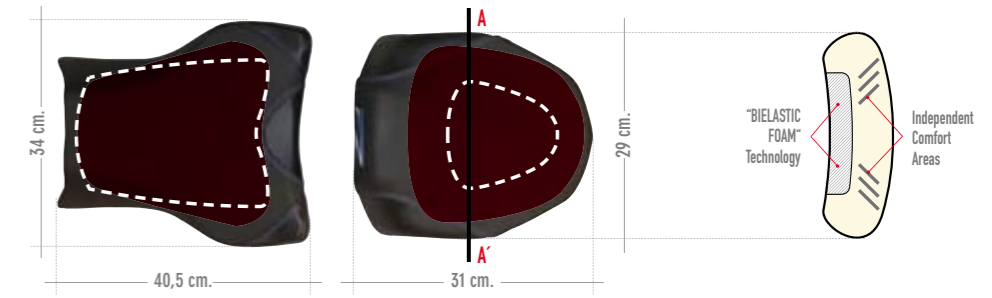

--- Bielastic Foam Technology ■ Contact Surface

YAMAHA FAZER FZ6



Ref.: SHYOF7000

FAZER FZ6 600 (04 - 10)

CHARACTERISTICS



See on page num. 8

AVAILABLE COLOURS



Ref.: SHYOF7000

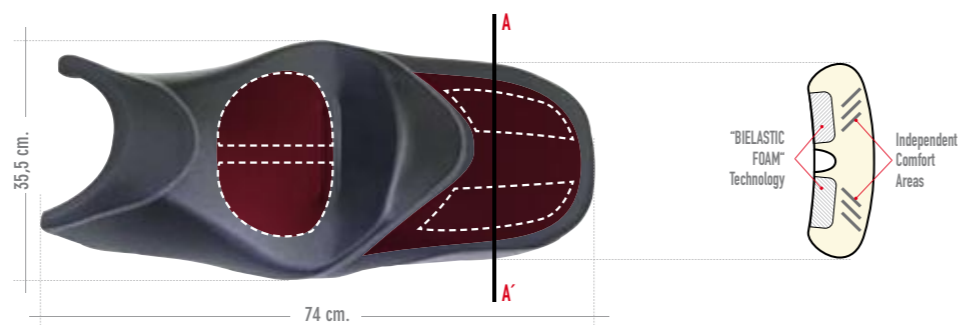

--- Bielastic Foam Technology ■ Contact Surface

YAMAHA XJ6



Ref.: SHYOX6100

XJ6 600 (10 - 11)

CHARACTERISTICS



See on page num. 8

AVAILABLE COLOURS

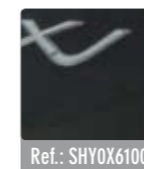

Ref.: SHYOX6100

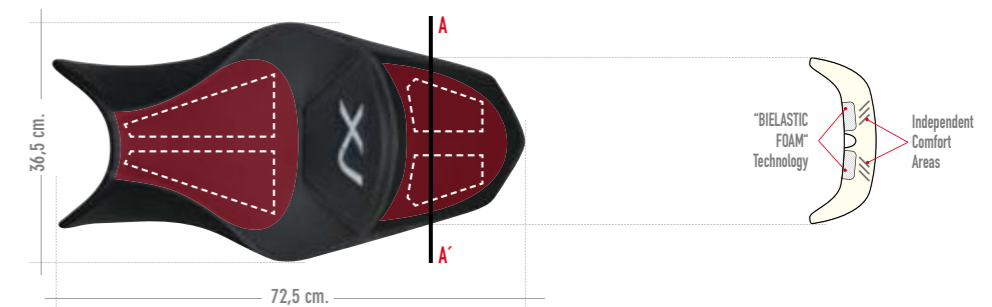

--- Bielastic Foam Technology ■ Contact Surface

KAWASAKI Z750/1000



Z 750 (07 - 11)
Z 1000 (07 - 09)



Ref.: SHK0Z1000C

CHARACTERISTICS



See on page num. 8

AVAILABLE COLOURS



Ref.: SHK0Z1000C Ref.: SHK0Z1020C Ref.: SHK0Z1007C Ref.: SHK0Z1004C

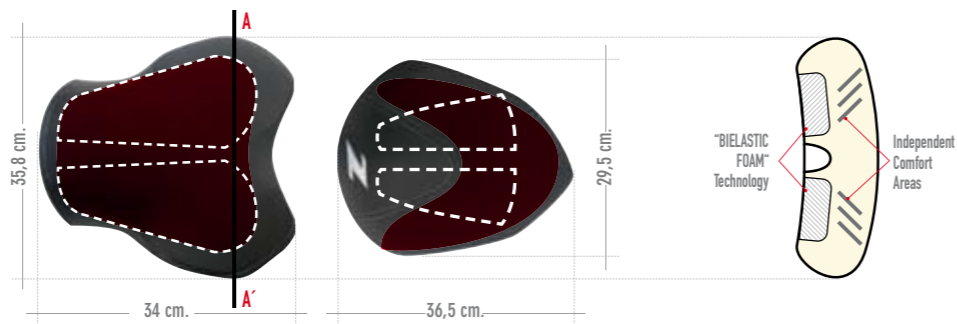

--- Bielastic Foam Technology ■ Contact Surface

SUZUKI GLADIUS



GLADIUS (09 - 11)



Ref.: SHS0G6020

CHARACTERISTICS



See on page num. 8

AVAILABLE COLOURS



Ref.: SHS0G6000 Ref.: SHS0G6010 Ref.: SHS0G6020

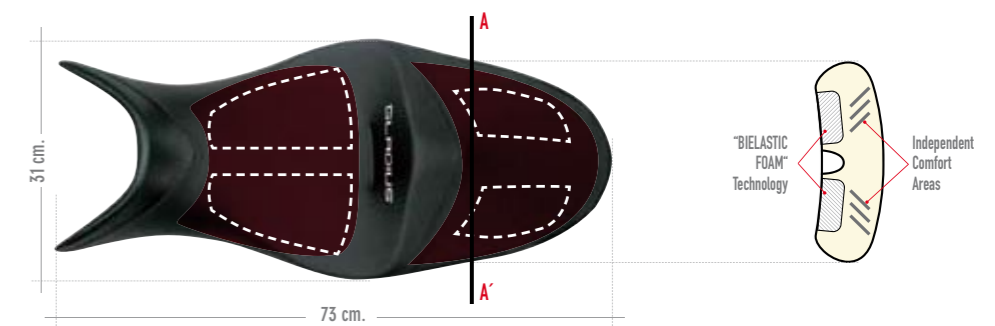

--- Bielastic Foam Technology ■ Contact Surface

KAWASAKI ER6



ER6 (09 - 11)



Ref.: SHK0E6000

CHARACTERISTICS



See on page num. 8

AVAILABLE COLOURS



Ref.: SHK0E6000 Ref.: SHK0E6107



--- Bielastic Foam Technology ■ Contact Surface

PIAGGIO MP3



MP3 RL (07 - 11)
MP3 RST 125/250/400 (09 - 11)
MP3 LT 250/400 (09 - 11)



Ref.: SHV0M2120

CHARACTERISTICS



See on page num. 8

AVAILABLE COLOURS



Ref.: SHV0M2110 Ref.: SHV0M2120

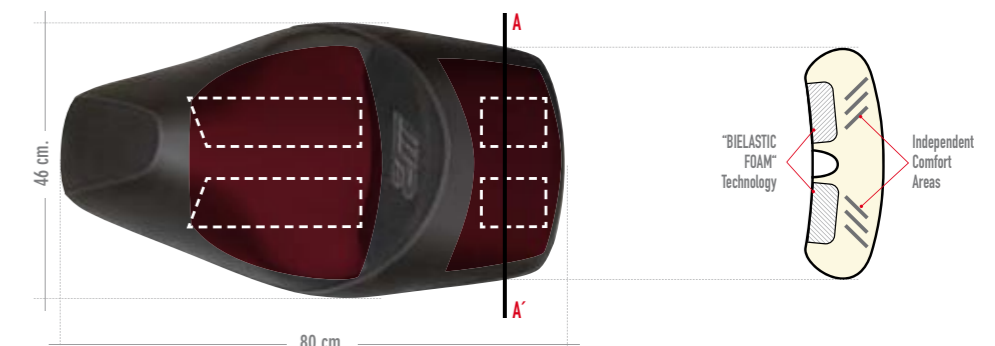

--- Bielastic Foam Technology ■ Contact Surface

SHAD
SOFT BAGS



SB70

REAR BAG

Ref.: XOSB70



SOFT BAGS



CHARACTERISTICS

Page 8



SB60

SADDLE BAG

Ref.: XOSB60



ACCESSORY Ref.: X1SB97

Thermo Pad
Kit Térmico
Kit Thermique
Hitzeschutz
Kit Termico



SB50

SADDLE BAG

Ref.: XOSB50



ACCESSORY Ref.: X1SB97

Thermo Pad
Kit Térmico
Kit Thermique
Hitzeschutz
Kit Termico



CHARACTERISTICS

Page 8



CHARACTERISTICS

Page 8



- Trolley transport system
- Sistema de transporte tipo "trolley"
- Système de transport type "trolley"
- Sistema di trasporto tipo "trolley"
- Sistema de transporte tipo "trolley"

SB90

BACKPACK

Ref.: XOSB90



SOFT BAGS



CHARACTERISTICS

Page 8



CHARACTERISTICS

Page 8



WHILE STOCK LAST



ACCESSORY Ref.: X1SB98

Suction
Ventosa
Ventouse
Saugnapf



SB30

TANK BAG

Ref.: XOSB30



SB80

BACKPACK

Ref.: XOSB80



CHARACTERISTICS

Page 8



CHARACTERISTICS

Page 8



ACCESSORY Ref.: X1SB10

Suction
Ventosa
Ventouse
Saugnapf



SB25

TANK BAG

Ref.: XOSB25



SB22

TANK BAG

Ref.: XOSB22



ACCESSORY Ref.: X1SB10

Suction
Ventosa
Ventouse
Saugnapf



SOFT BAGS

CHARACTERISTICS

Page 8



CHARACTERISTICS

Page 8



ACCESSORY Ref.: X1SB10

Suction
Ventosa
Ventouse
Saugnapf



SB15

GPS TANK BAG

Ref.: XOSB15



SB20

TANK BAG

Ref.: XOSB20



WHILE STOCK LAST

ACCESSORY Ref.: X1SB98

Suction
Ventosa
Ventouse
Saugnapf



CHARACTERISTICS

Page 8



CHARACTERISTICS

Page 8



ACCESSORY Ref.: X1SB98

Suction
Ventosa
Ventouse
Saugnapf



SB10

GPS TANK BAG

Ref.: XOSB10



WHILE STOCK LAST



SB12

TANK POUCH MAGNET Ref.: X0SB12M

TANK POUCH SUCTION Ref.: X0SB12S



CHARACTERISTICS

Page 8

Ref.: X0SB12M



Ref.: X0SB12S



SB11

TANK POUCH

Ref.: X0SB11



CHARACTERISTICS

Page 8



SC30

SCOOTER BAG

Ref.: X0SC30



CHARACTERISTICS

Page 8



SC20

SCOOTER BAG

Ref.: X0SC20



CHARACTERISTICS

Page 8



SB45

HOLSTER BAG

Ref.: XOSB45



SOFT BAGS



CHARACTERISTICS

Page 8



CHARACTERISTICS

Page 8



SBT2

TOOL BAG

Ref.: XOSBT2



SB40

HOLSTER BAG

Ref.: XOSB40



CHARACTERISTICS

Page 8



SBT1

TOOL BAG

Ref.: XOSBT1



SHAD
ATV CASES ❖



ATV CASES

Fitting # Inclued
 Fijación # Incluída
 Fixation # Includé
 Befestigung # Inbegriffen
 Atacco # Inclusa
 Fixação # Incluída



Backrest # Included
 Respaldo # Incluído
 Dossieret # Inclus
 Rückenpolster # Inbegriffen
 Schienale # Incluso
 Encosto # Incluído



ACCESSORY
 Ref.: DOPMQ
 Luggage rack
 Porta-paquetes
 Porte-objet
 Gepäckgitter
 Portapacchi
 Porta-bagagem



High safety lock & Reflector
 Cierre de alta seguridad & Catadióptrico
 Fermeture de sécurité & Réflechissant
 SicherVerschlußsystem & Reflektor
 Chiusura di alta sicurezza & Catarifrangente
 Fachadura de alta segurança & Refletor



- Greatest capacity
- Máxima capacidad
- La plus grande capacité
- Maximale Kapazität
- Massima capacità
- Mxima capacidade



CHARACTERISTICS

Page 8



15

SHATV110

Ref.: D001100



ATV CASES

Fitting # Included
 Fijación # Incluida
 Fixation # Includere
 Befestigung # Inbegriffen
 Atacco # Inclusa
 Fixação # Incluída



Backrest # Included
 Respaldo # Incluído
 Dossieret # Inclus
 Rückenpolster # Inbegriffen
 Schienale # Incluso
 Encosto # Incluído



High safety lock
 Cierre de alta seguridad
 Fermeture de sécurité
 SicherVerschlußsystem
 Chiusura di alta sicurezza
 Fachadura de alta segurança



Reflector
 Catadióptrico
 Réflechissant
 Reflektor
 Catarifrangente
 Refletor



- Greatest capacity
- Máxima capacidad
- La plus grande capacité
- Maximale Kapazität
- Massima capacità
- Máxima capacidade

CHARACTERISTICS

Page 8



15

SHATV80

Ref.: D0Q800



ATV CASES

Fitting # Includa
 Fijación # Incluida
 Fixation # Includa
 Befestigung # Inbegriffen
 Atacco # Includa
 Fixação # Includa



Locking
 Cierre
 Fermeture
 Verschluss
 Chiusura
 Fecho



Reinforced finishes
 Acabados reforzados
 Finitions renforcées
 Verstärkte ausführung
 Rinforzi nelle finiture
 Acabamentos reforçados



- Innovative design
- Diseño innovador
- Design innovateur
- Innovatives design
- Disegno inovativo
- Design inovador



CHARACTERISTICS

Page 8



SHATV40

Ref.: D0Q200

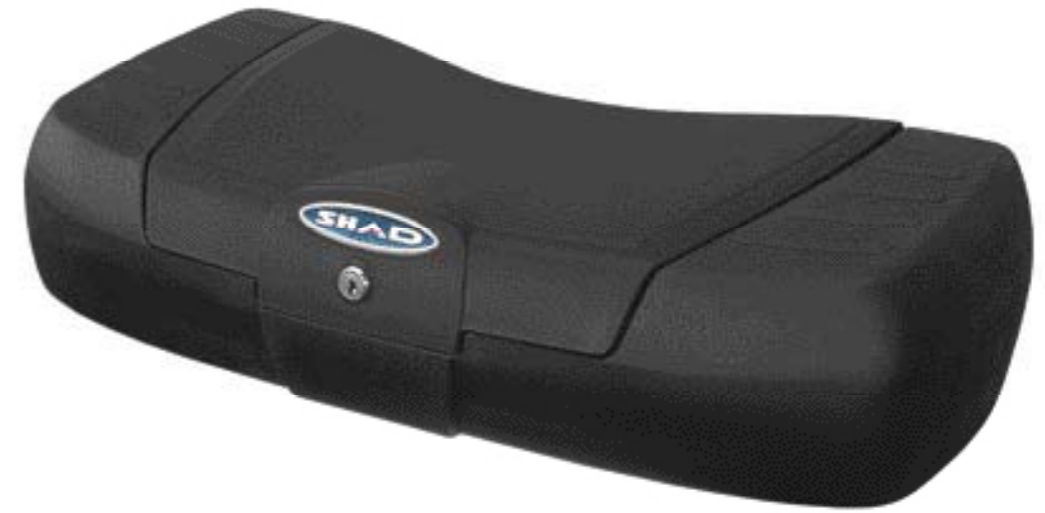

ATVBAG50

Ref.: X0ATVS50



CHARACTERISTICS

Page 8



ATVBAG100

Ref.: X0ATVS100



CHARACTERISTICS

Page 8



- Greatest capacity
- Máxima capacidad
- La plus grande capacité
- Maximale Kapazität
- Massima capacità
- Mxima capacidade

SHAD

MOTORCASES SPARE PARTS ❖

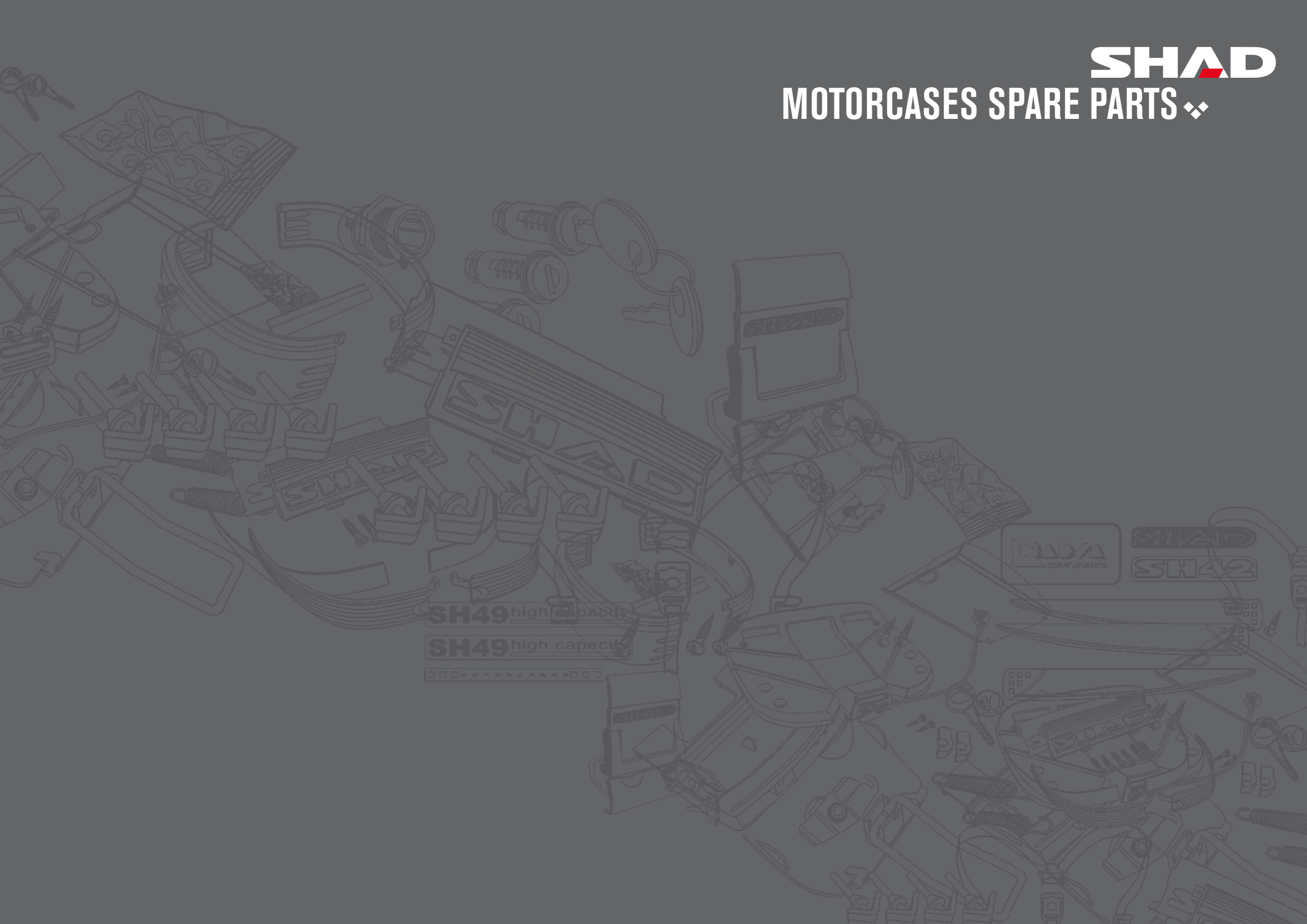

SH49 high capacity



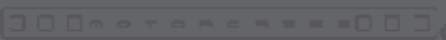

SH49 high capacity





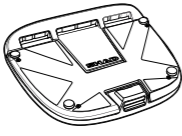
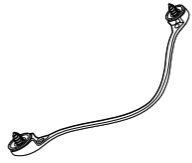
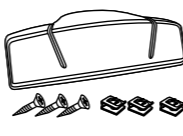
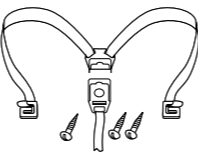
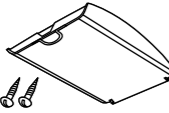
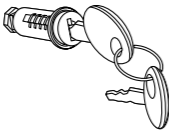

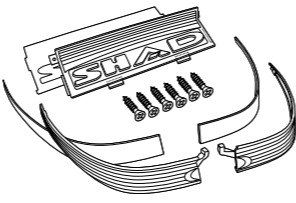
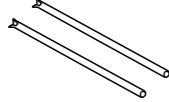

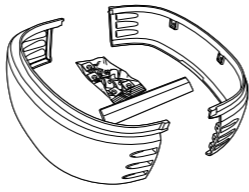

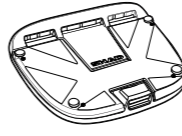

NADIA
COMPONENTS

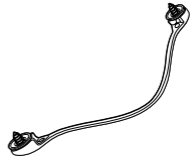
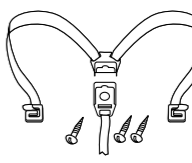
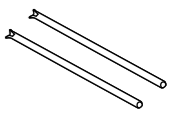
SHAD
SH42

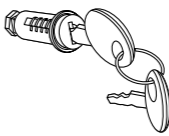

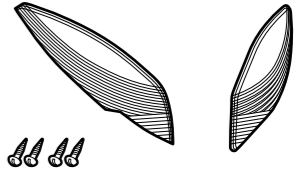

SH50

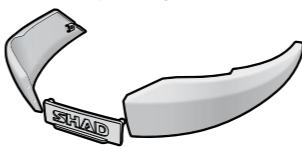
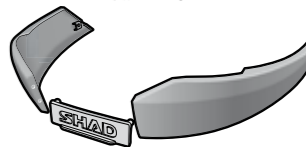
Ref.: D1B40BOR 	Ref.: D1B48PAR 	Ref.: D1B1TIR 	Ref.: D0R170 	Ref.: D1B50CGR 
Ref.: 200583R 	Ref.: 201722R 	Ref.: 200799R 	Ref.: D1B50CAR 	
Ref.: 200784R 	Ref.: D1B50MAR 	Ref.: 400316R 	Ref.: D1B50EMR 	



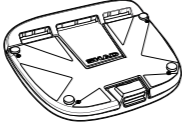
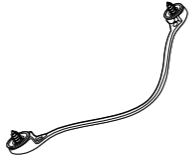
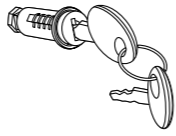
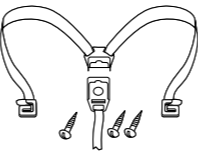
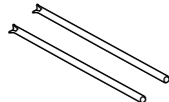

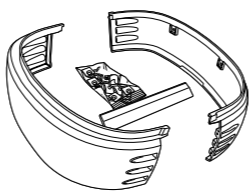
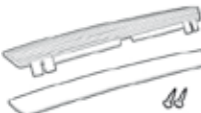
SH48 NEW TITANIUM DARK GREY

Ref.: D1B48PAR 	Ref.: D1B40BOR 	Ref.: D1B1TIR 	Ref.: D1B48CGR 	Ref.: 200784R 
Ref.: 200799R 	Ref.: 201896R 	Ref.: 400316/1R 	Ref.: D1B48CAR 	
Ref.: D1B482MAR 	Ref.: D1B482ETR 		Ref.: D1B481MAR 	Ref.: D1B481ETR 
Ref.: D1B482EMR 		Ref.: D1B481EMR 		

SH49

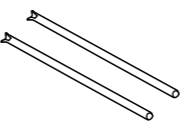
Ref.: D1B40BOR 	Ref.: D1B48PAR 	Ref.: D1B1TIR 	Ref.: 201722R 	Ref.: D1B50CGR 
Ref.: 200784R 	Ref.: D1B49MAR 	Ref.: 200799R 	Ref.: D1B49EMR 	
Ref.: D1B49CAR 	Ref.: D1B49ETR 		Ref.: D1B49CLR 	

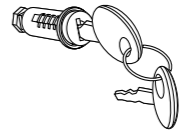
SH46

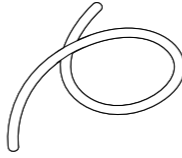
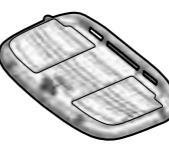
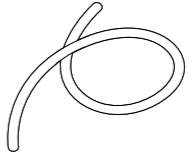
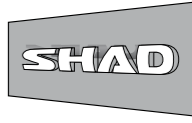
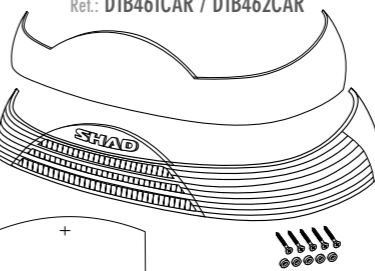
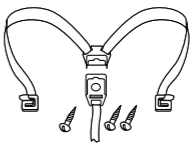
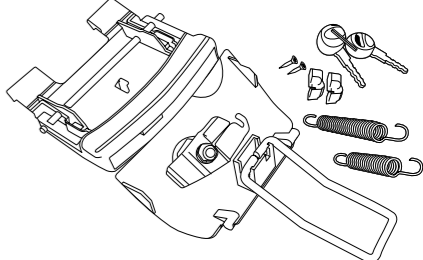
Ref.: 201121R 	Ref.: D1B40BOR 	Ref.: 201722R 	Ref.: D1B461ETR 
Ref.: 400253R 	Ref.: D1B40PAR 	Ref.: D1B2TIR 	
Ref.: D1B461CAR / D1B462CAR 		Ref.: D1B4CGR 	Ref.: D1B46MAR 

SH45

Ref.: 201121R 	Ref.: D1B40B0R 	Ref.: 201722R 	Ref.: D1B45ETR (RED) 	Ref.: D1B451ETR (WHITE) 	Ref.: D1B1T1R
Ref.: D1B45CGR 	Ref.: 400271R 	Ref.: D1B45MAR 	Ref.: D1B40PAR 	Ref.: D1B45CAR (RED) / Ref.: D1B451CAR (WHITE) 	

SH40 CARGO

Ref.: 201121R 	Ref.: D1B40B0R 	Ref.: 201722R 	Ref.: D1B40ETR (RED) 	Ref.: D1B401ETR (WHITE) 	Ref.: D1B40PAR 	Ref.: D1B45MAR
Ref.: D1B40PTR 	Ref.: 400271R 	Ref.: D1B40CAR (RED) / Ref.: D1B401CAR (WHITE) 		Ref.: D1B1T1R 		

SH43 SIDE CASE

Ref.: D1B43CAR (RED) Ref.: D1B431CAR (WHITE) 	Ref.: 201121R 	Ref.: D1B43ETR (RED) 	Ref.: D1B431ETR (WHITE) 	Ref.: D1B4CGR 	Ref.: D1B43MAR
Ref.: D1B4T1R 	Ref.: 400269/1R 	Ref.: 200062R 			

SH37

201121R 	Ref.: D1B37B0R 	Ref.: 201722R 	Ref.: 400271R 	Ref.: D1B371ETR 	Ref.: D1B1T1R
Ref.: D1B37PAR 		Ref.: D1B371CAR 		Ref.: D1B37MAR 	

SH42 SIDE CASE

Ref.: 201121R 	Ref.: D1B40B0R 	Ref.: 200137R 	Ref.: 200062R
Ref.: D1B40PAR 	Ref.: D1B3T1R 	Ref.: 400253R 	Ref.: D1BNMAR
Ref.: D1BNETR 		Ref.: D1B4CGR 	







SH33

Ref.: 201121R 	Ref.: D1BAB0R 	Ref.: 201722R 	Ref.: D1B33ETR (RED) 	Ref.: D1B331ETR (WHITE) 	Ref.: D1B1T1R
Ref.: D1B29PAR 		Ref.: D1B33CAR (RED) 	Ref.: D1B331CAR (WHITE) 		Ref.: D1B33MAR

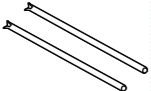
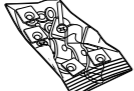
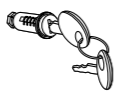



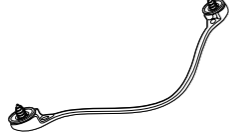
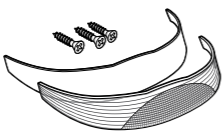

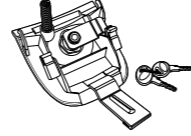
SH32 CUSTOM

Ref.: 201121R 	Ref.: D1BAB0R 	Ref.: 201722R 	Ref.: D1B32CAR 		
Ref.: D1B29PAR 		Ref.: D1B32ETR 		Ref.: D1B32MAR 	

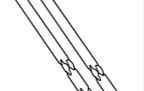



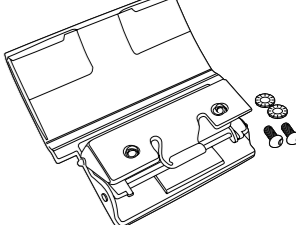
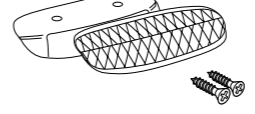

SH29

Ref.: 201121R 	Ref.: D1BAB0R 	Ref.: 201722R 	Ref.: D1B29ETR (RED) 	Ref.: D1B291ETR (WHITE) 	Ref.: D1B29PAR 
Ref.: D1B1TIR 	Ref.: D1B29CAR (RED) 	Ref.: D1B291CAR (WHITE) 	Ref.: D1B29MAR 		

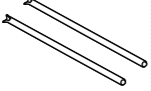

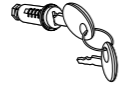
SH29 ATV80

Ref.: 200452R 	Ref.: S1Q8B0R 	Ref.: 200451R 	Ref.: 500545R 	Ref.: D1TV80R 
Ref.: D1BQ8CAR 		Ref.: DOR150 		

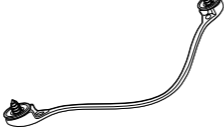
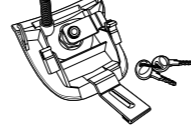

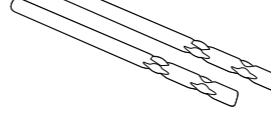
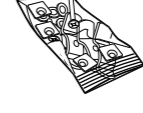
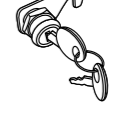

SH26

Ref.: 201121R 	Ref.: D1BAB0R 	Ref.: 201722R 	Ref.: D1B26CAR (RED) 	Ref.: D1B261CAR (WHITE) 
Ref.: D1B29PAR 		Ref.: D1B1TIR 	Ref.: D1B29MAR 	

SH26 ATV40

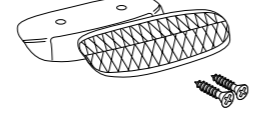
Ref.: 201481R 	Ref.: S1Q8B0R 	Ref.: 200537R 	Ref.: 500545R 
--	--	--	--

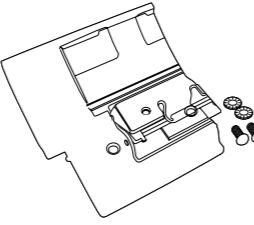
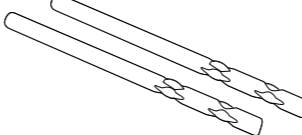
SH26 SHATV110

Ref.: 200537R 	Ref.: D1BQ8CAR 	Ref.: DOR150 
Ref.: S1Q8B0R 	Ref.: D1TV80R 	Ref.: 201528R 
Ref.: D1Q11ETR 		

ATV110 SHAD

DISPLAYS

Expositores · Présentoirs · Austeller · Espositori · Expositores



Ref.: 2 DOEX02 + 1 DOEX10 + 1 DOEX03
9 Top Cases



Ref.: DOEX02 or DOEX10
3 Top Cases



Ref.: DOEX13
Top Case + Side Case